

SOLENOID OPERATED CARTRIDGE

CEBN-080-NCFN-01

PILOT OPERATED
POPPET TYPE

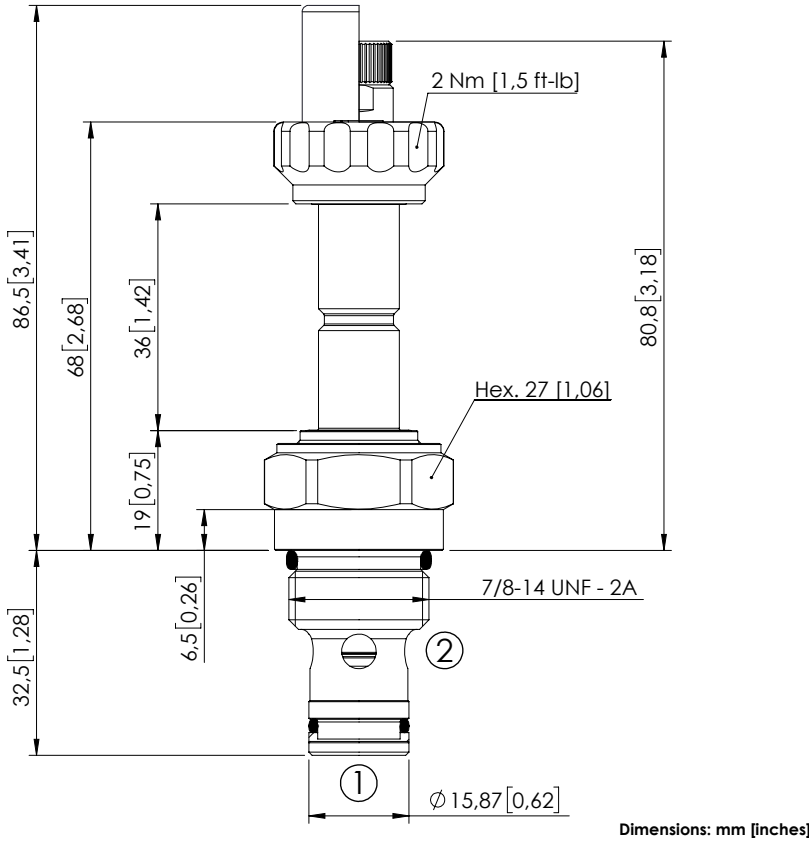

Dimensions: mm [inches]

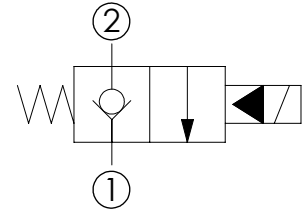

SPECIFICATIONS

Max. operating pressure:	350/500 bar (5000/7200 psi)
Rated flow:	80 l/min (21 gpm)
Cavity:	SAE-10-2N
Weight:	0,18 kg (0,40 lbs)
Min. voltage required:	90% of nominal
Coil type:	M7 or M3 type
Ambient temperature:	-20/+50 °C (-4/+122 °F)
Contamination class to ISO 4406:	See technical spec.
Seal kit:	RA900082
Installation torque:	55 - 62 Nm (401 - 46 ft-lb)
MTF _d :	150 - 1200 years: See technical spec.

NOTES

For other configurations/quick codes not available in this catalogue page please consult factory

CURVES

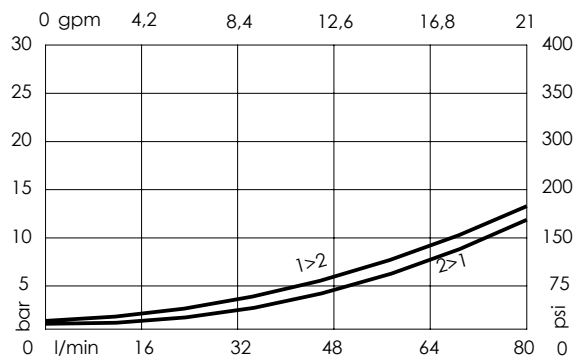

OPTIONS

Standard



Knob style
override



SEALING CAP

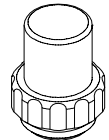

Ordering code:
AT000113

ORDERING CODES

Quick code	Description	Options	Max operating pressure
CE000245	CEBN-080-NCFN-01-S10-N350	Standard	350 bar (5000 psi)
CE000247	CEBN-080-NCFK-01-S10-N350	Knob style override	350 bar (5000 psi)
CE000545	CEBN-080-NCFN-01-S10-N500	Standard	500 bar (7200 psi)
CE000547	CEBN-080-NCFK-01-S10-N500	Knob style override	500 bar (7200 psi)